

Sauna 220

Packliste und Montageanleitung

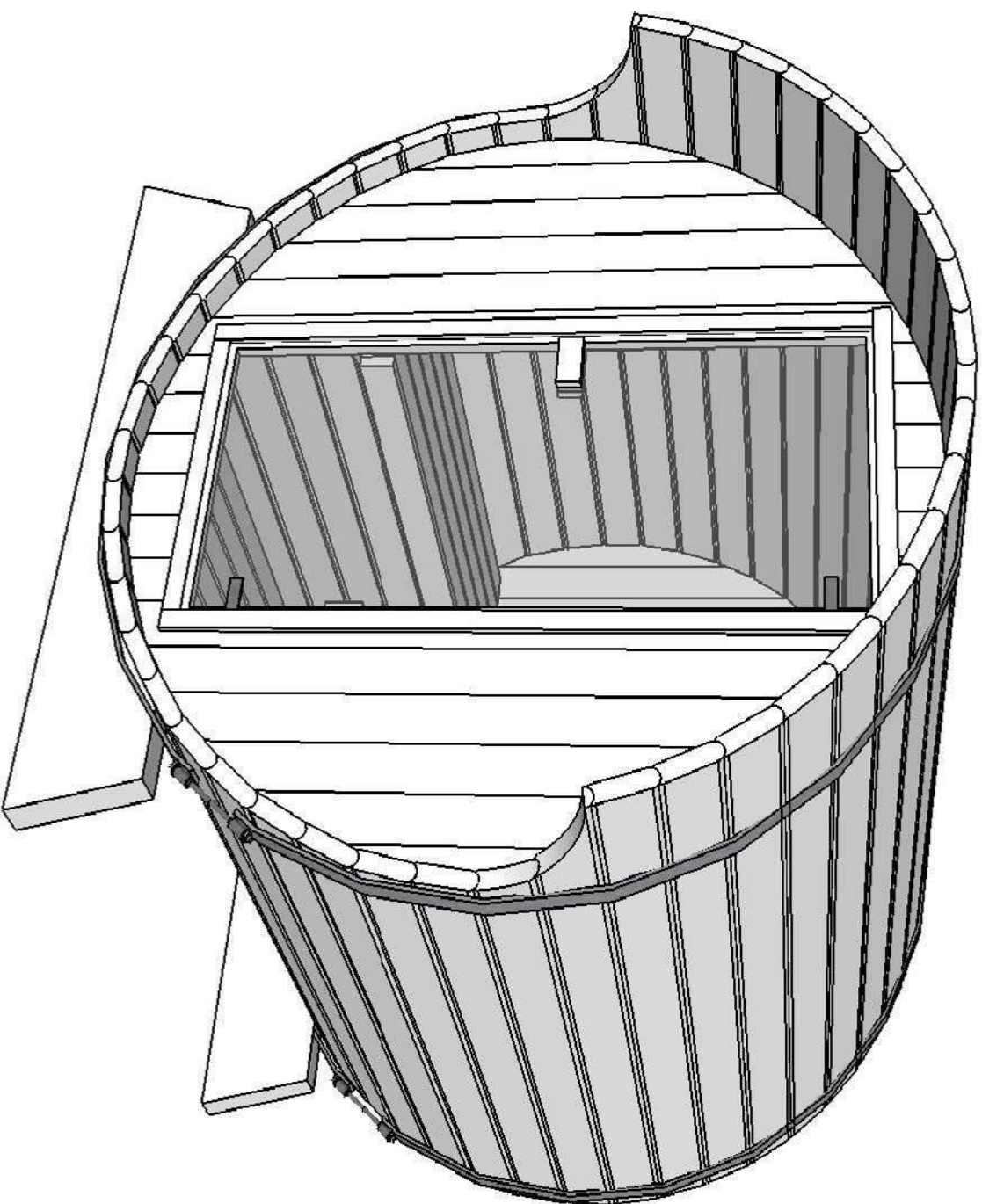

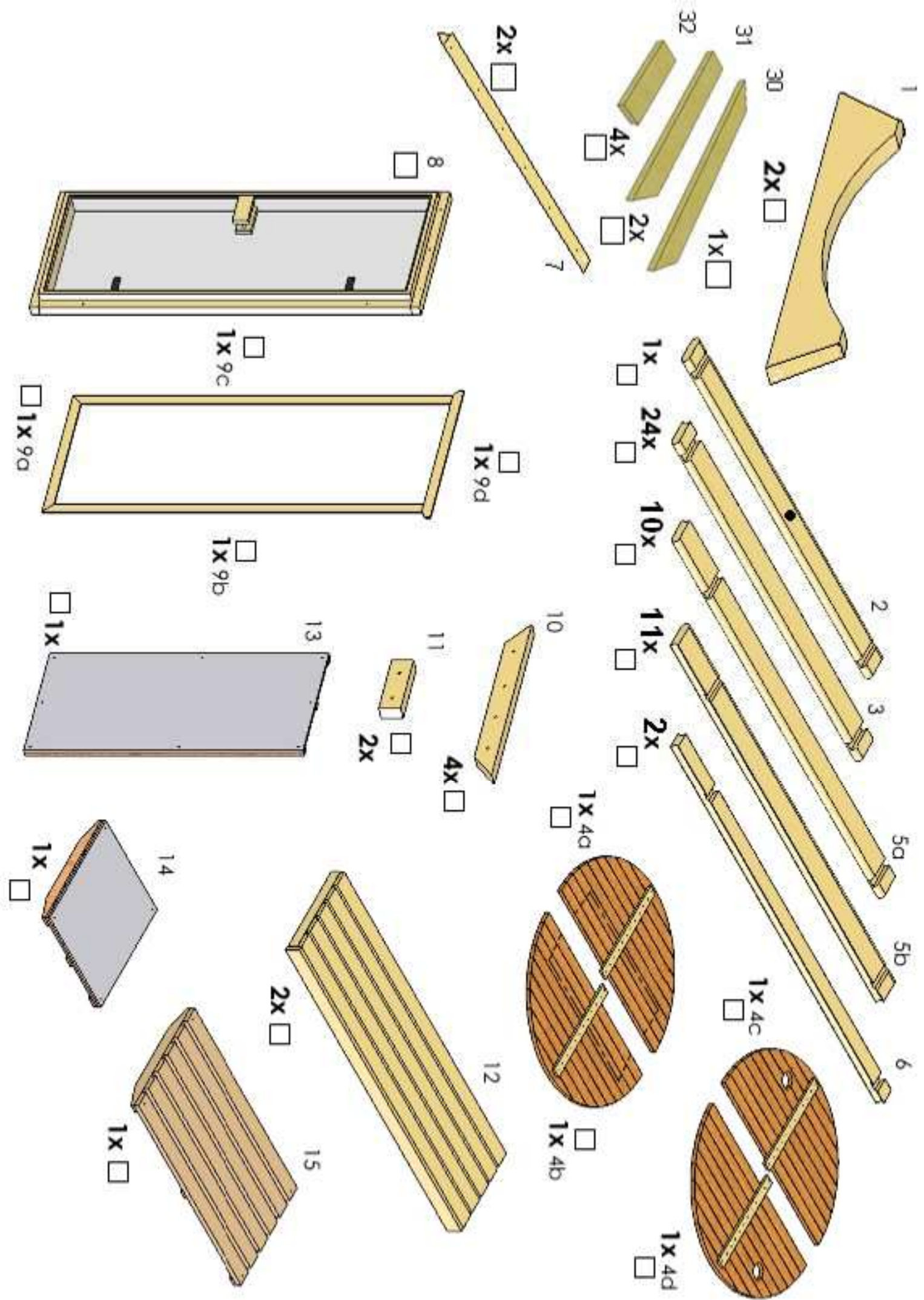

1800 mm. L



2x □

A

2x □

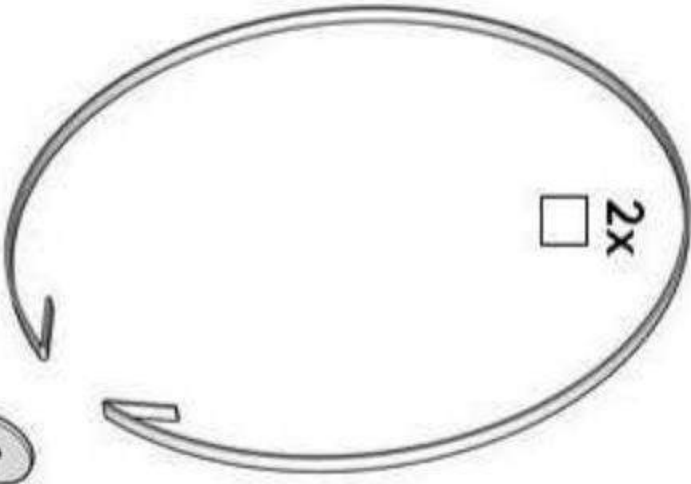

4x □

A1



R



3x □

S

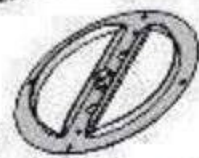

1x □

Y

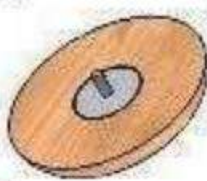

1x □

B



2x □

C



4x □

D



4x □

Ø 3x30

H

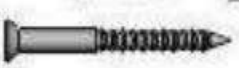

12x □

Ø 3,5x40

J

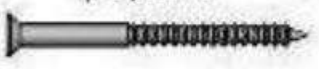

12x □

Ø 4x50

M



62x □

Ø 4,5x60

M



98x □

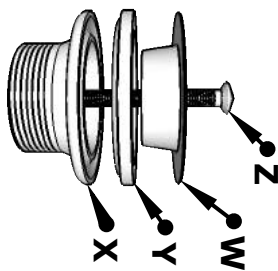

x1 □

600 mm.

T



2x □

Ø 1200 mm.

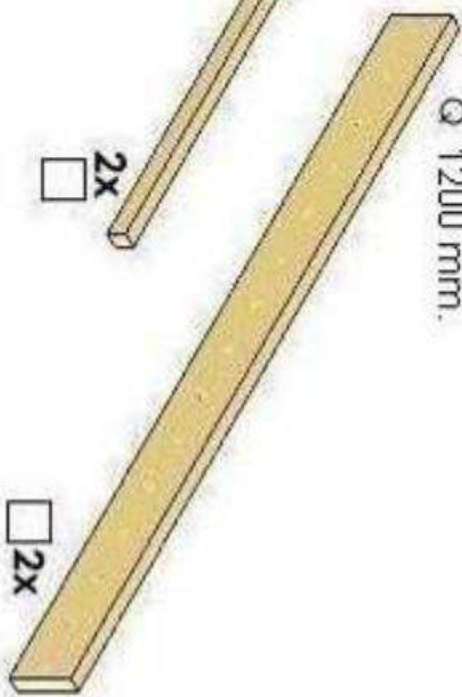

2x □

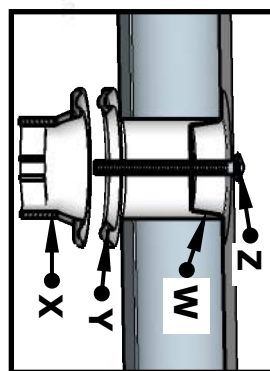

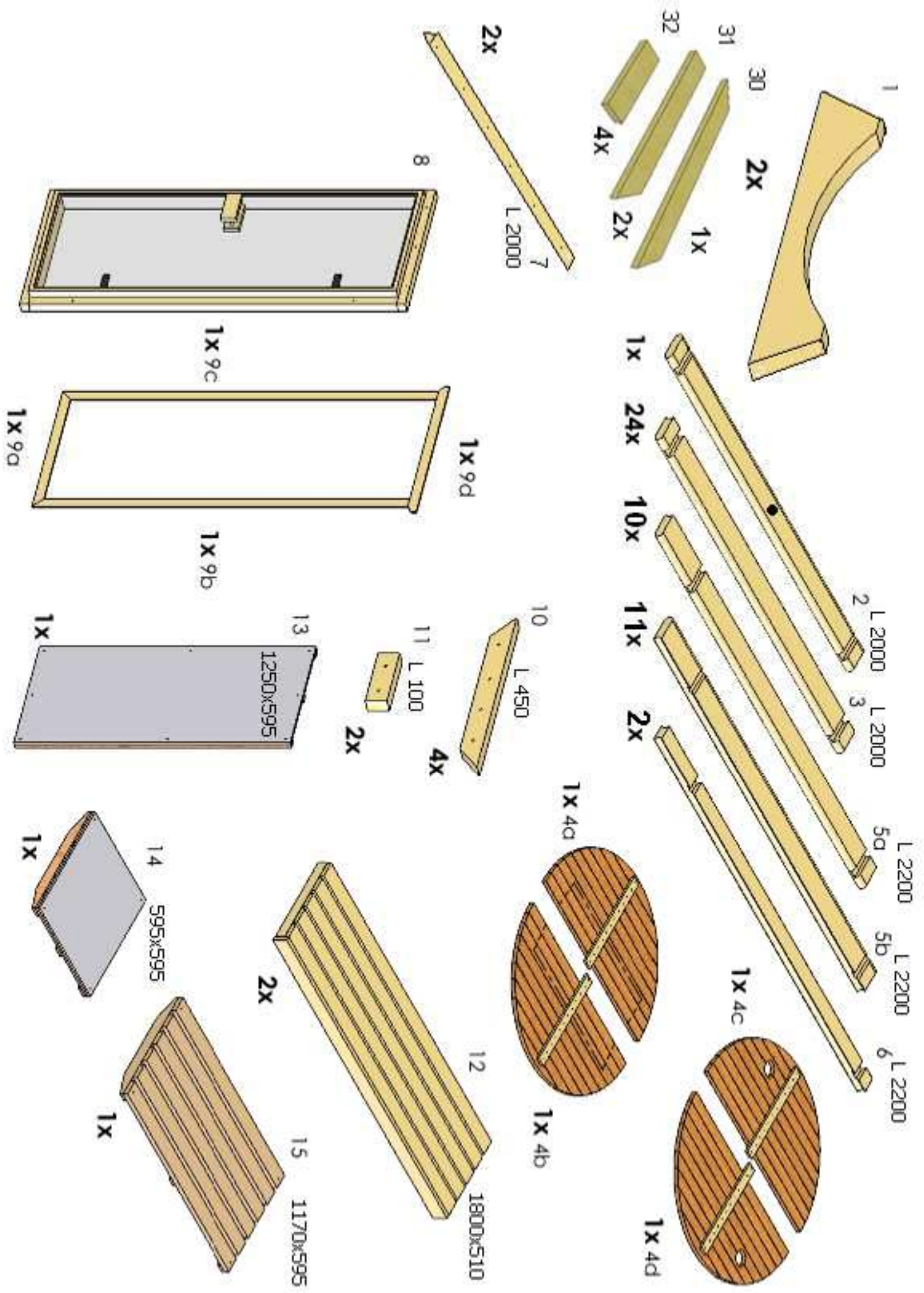

1800 mm. L



2x □

A

2x □

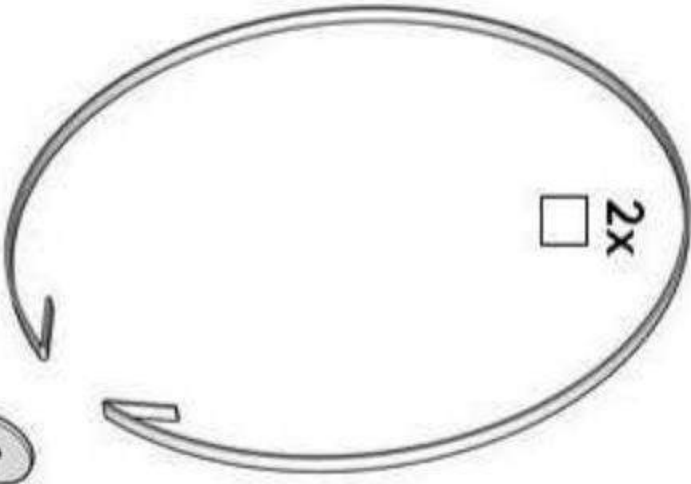

4x □

A1



R



3x □

S

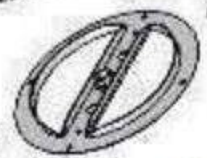

1x □

Y

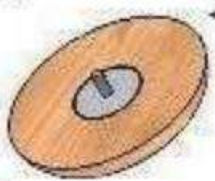

1x □

B



2x □

D



4x □

C



4x □

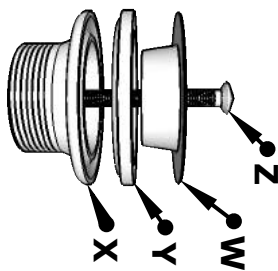

x1 □

600 mm.

T

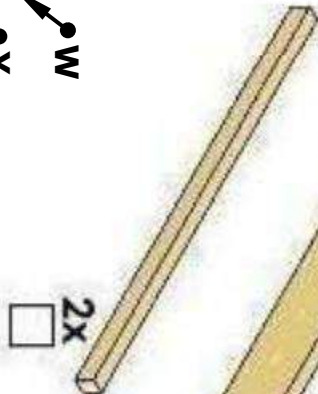

2x □

Ø 1200 mm.

2x □

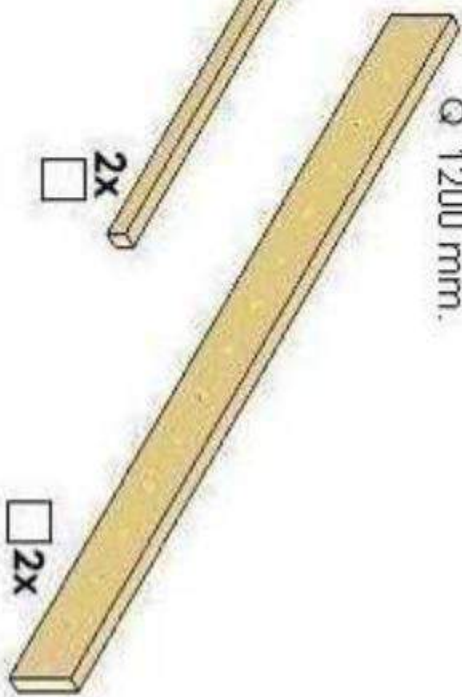

Ø 3x30

H

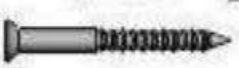

12x □

Ø 3,5x40

J

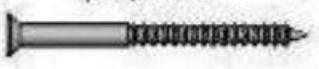

12x □

Ø 4x50

M



62x □

Ø 4,5x60

M



98x □

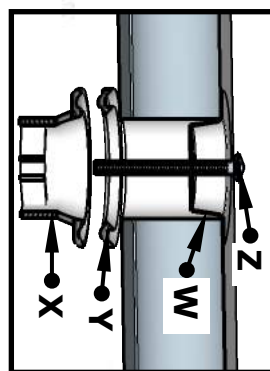

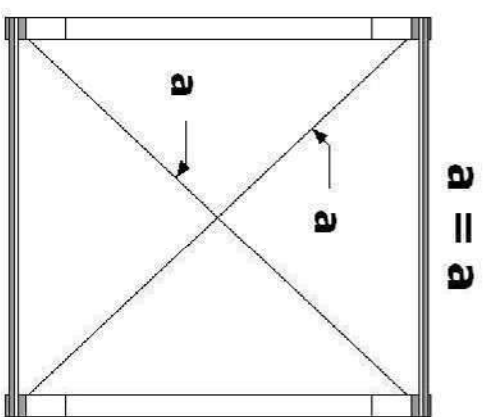
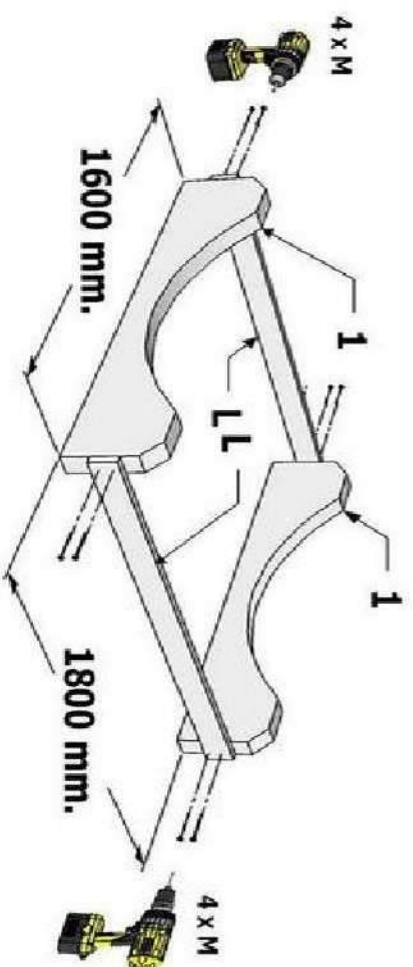
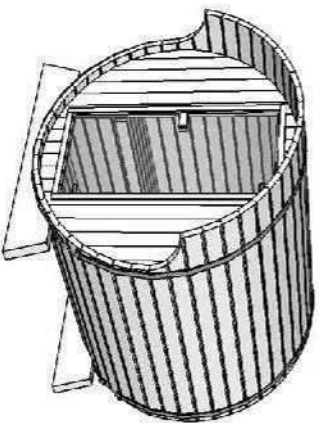

Anfangsbohle unten mit Loch in der Mitte

10 x DET 3

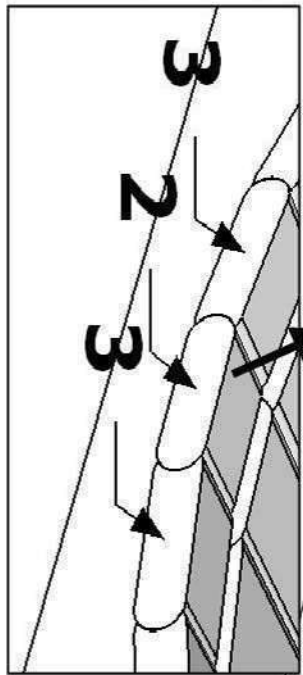
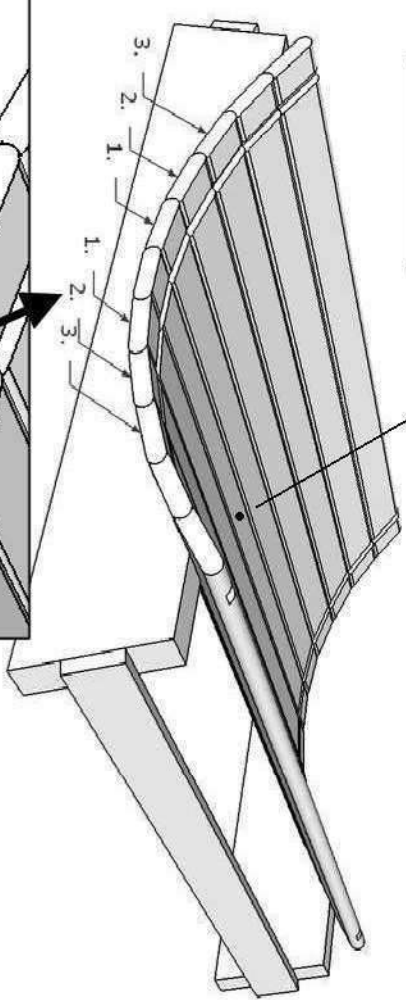
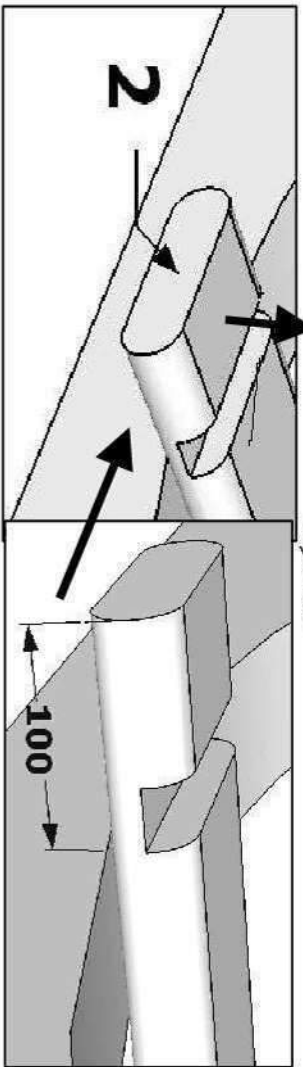
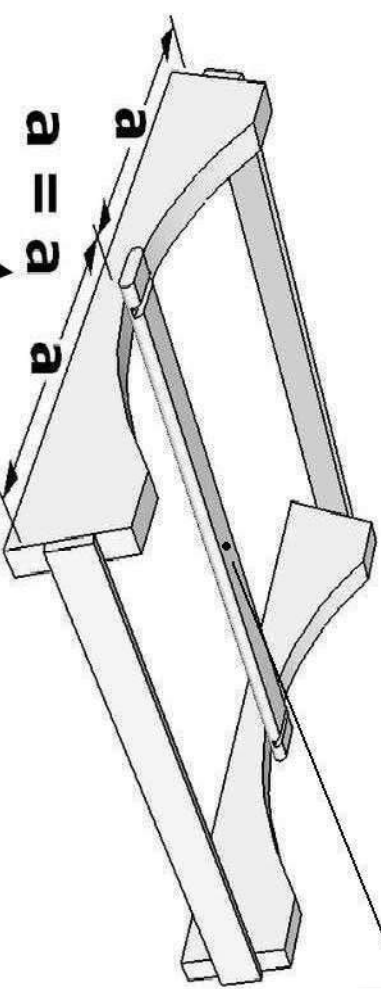

1

2

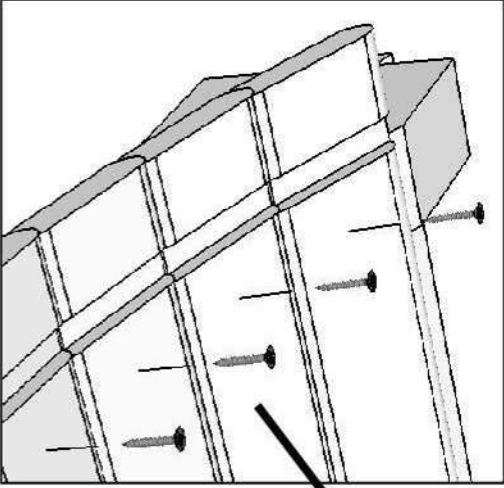
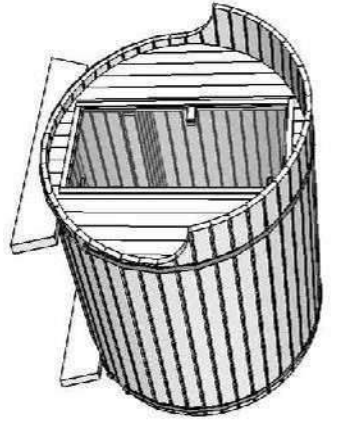

11 x M

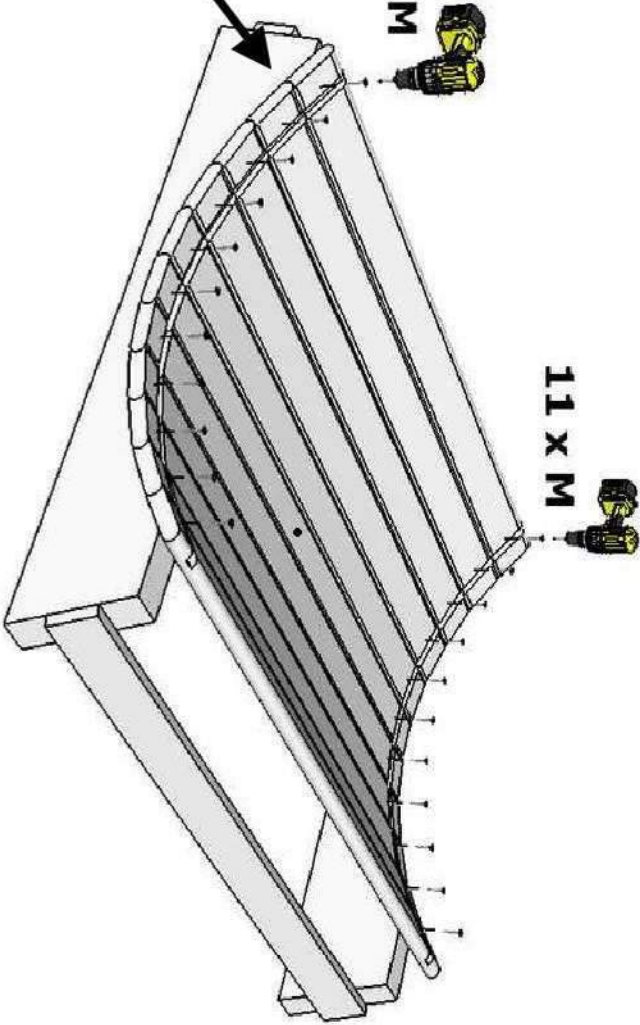

11 x M

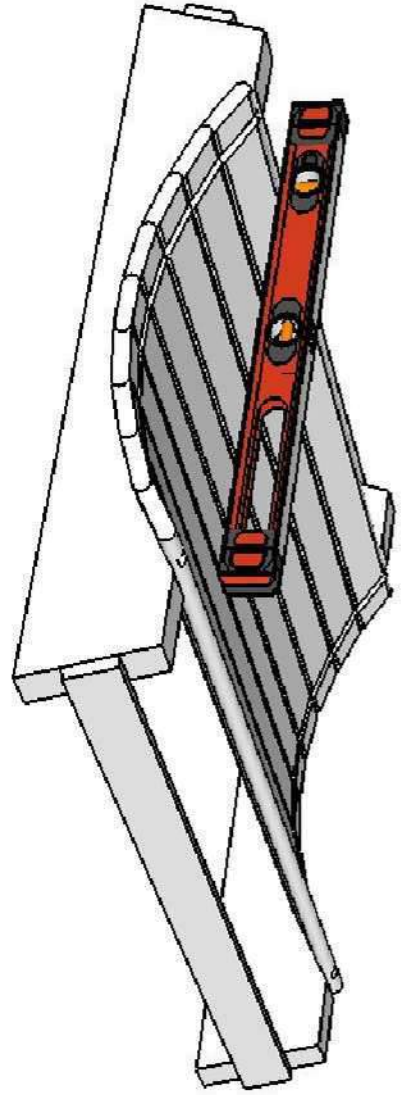

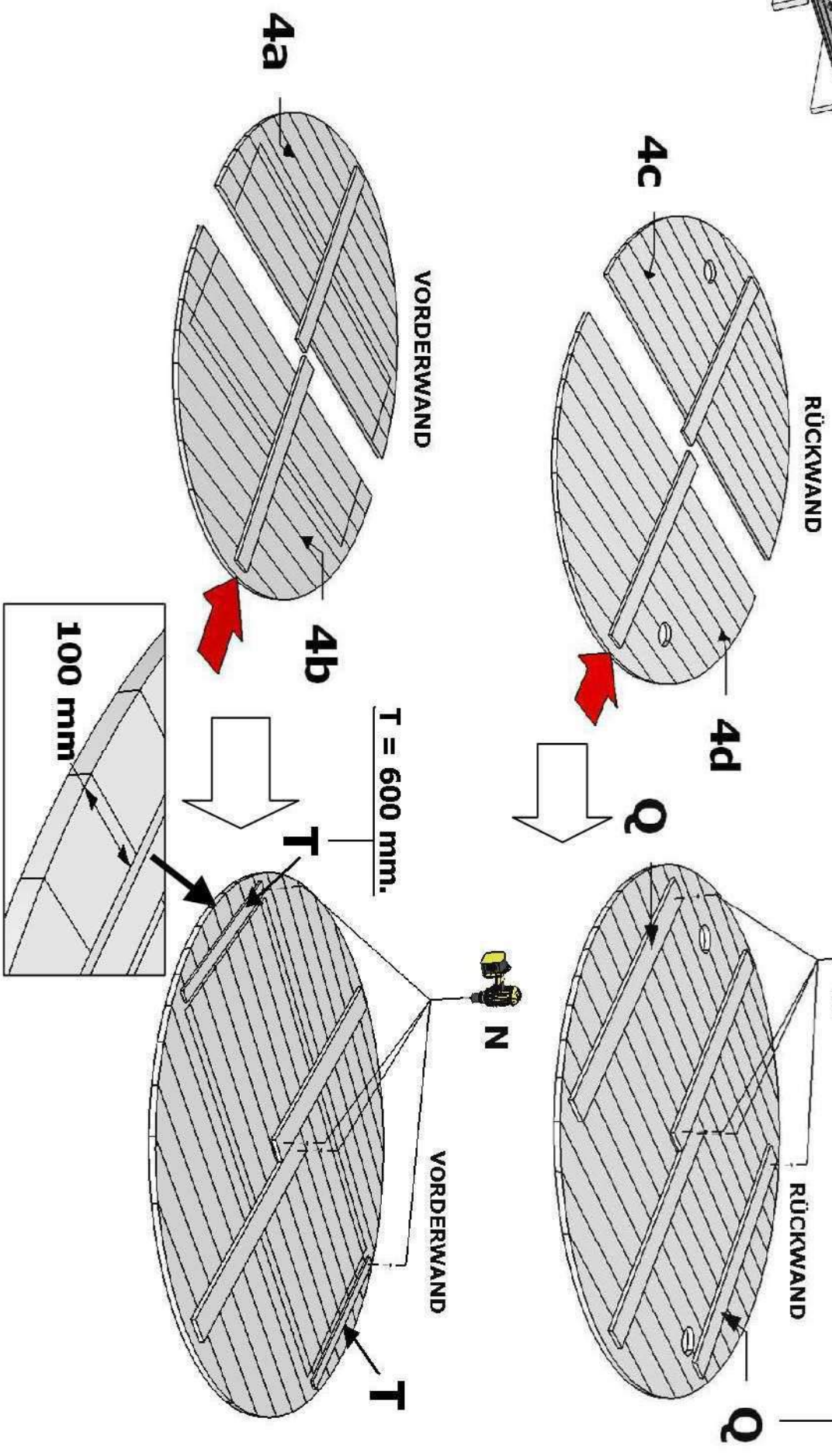
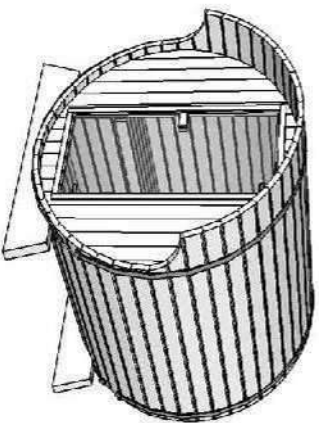

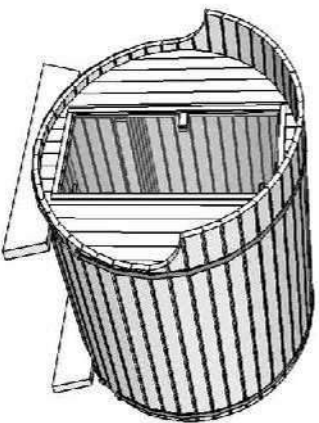

14 x DET 3

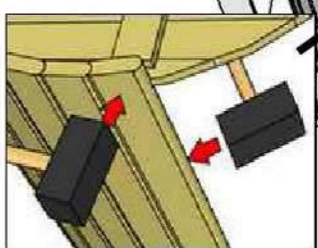
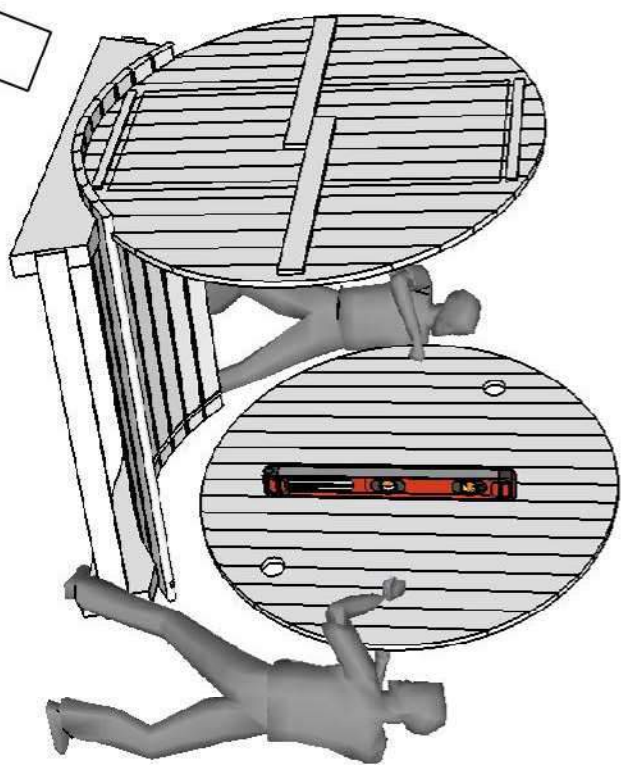
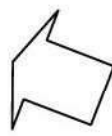

14 x M

14 x M

10 x DET 5a
11 x DET 5b

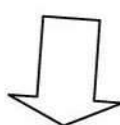

2 x DET 6

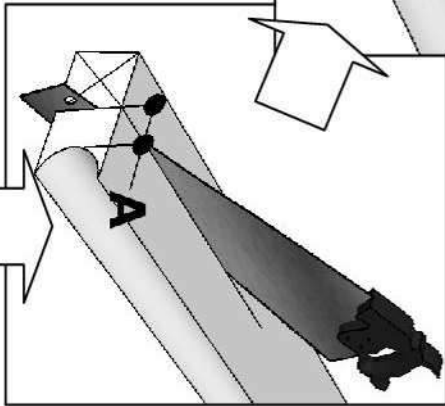
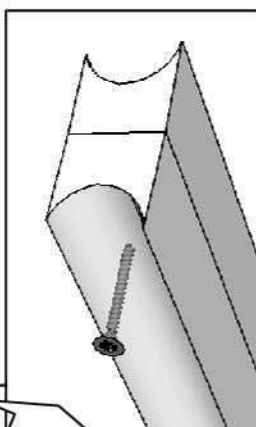
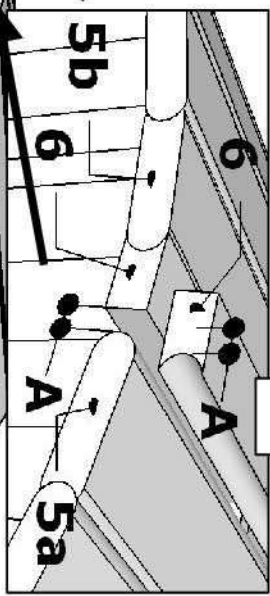

4

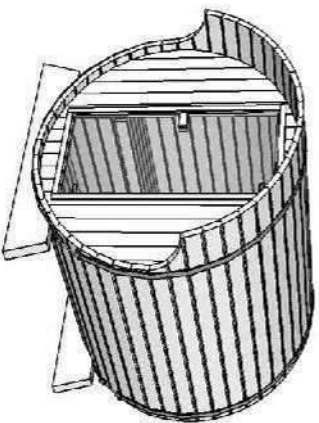

ENTFERNEN

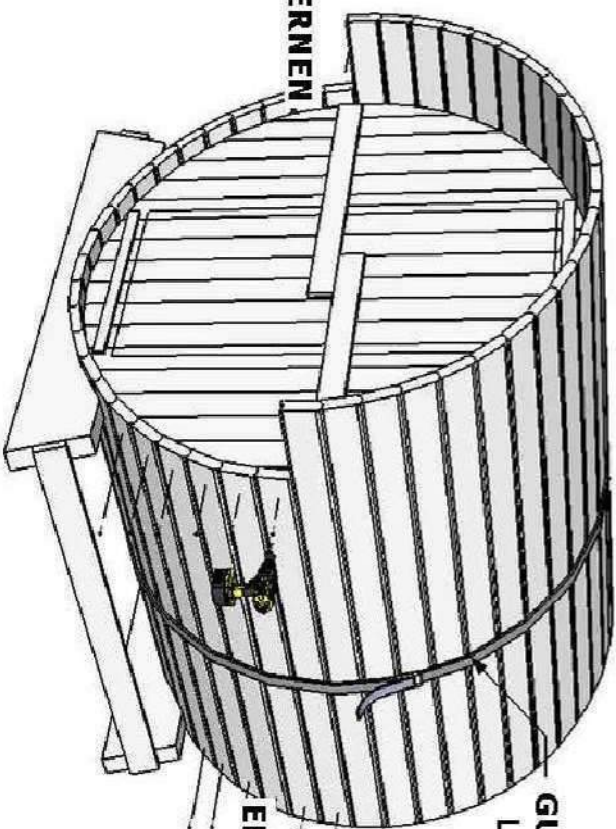

ENTFERNEN

GURT
L = 8 m.

2 x A

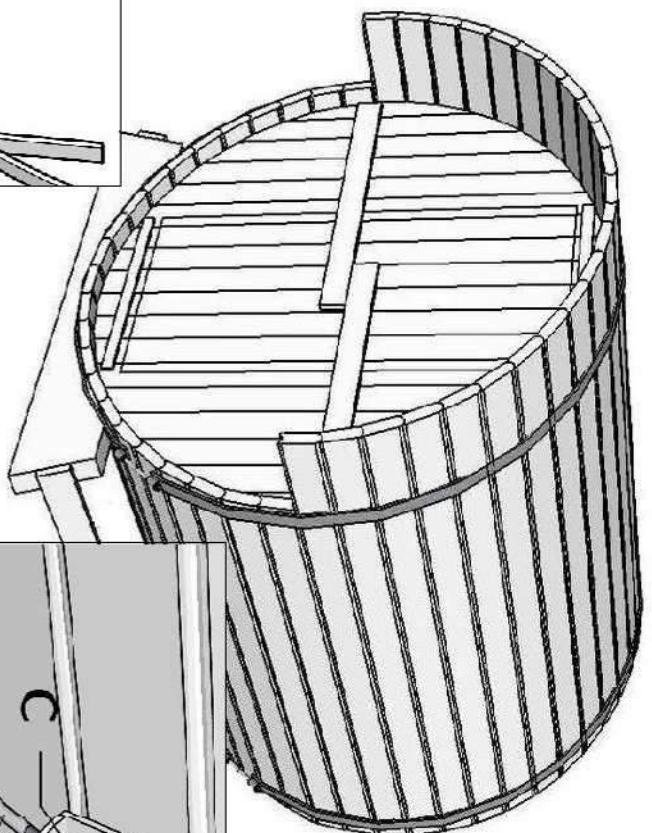

5

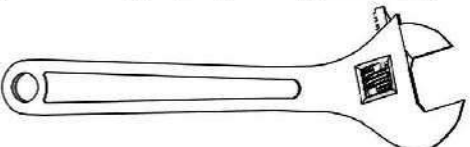
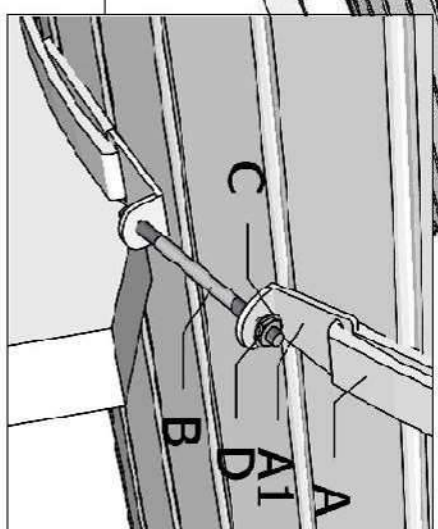
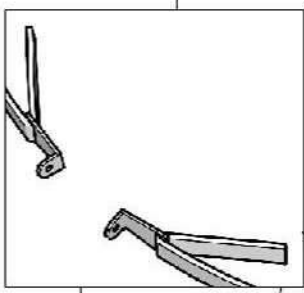
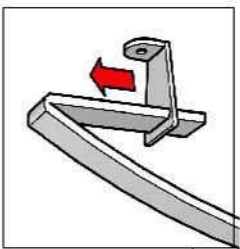

9

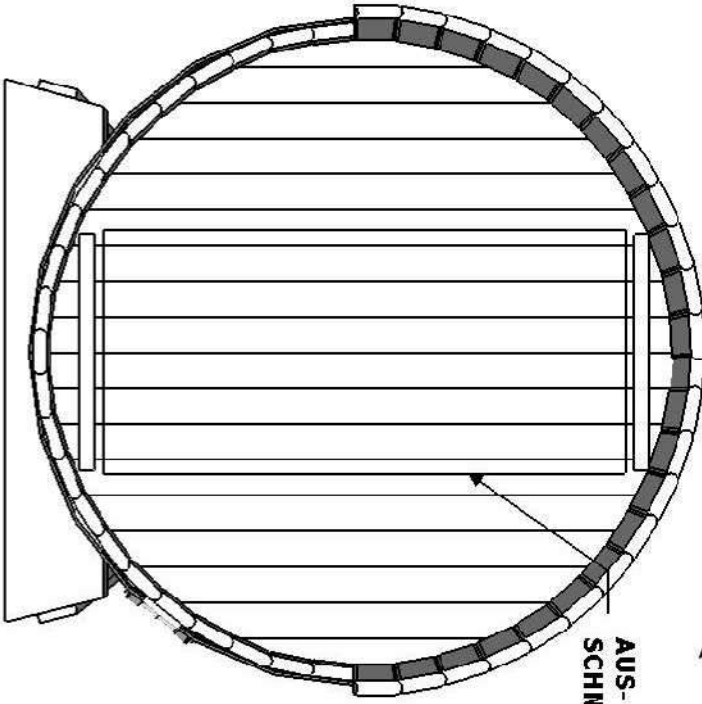

AUS-
SCHNEIDEN

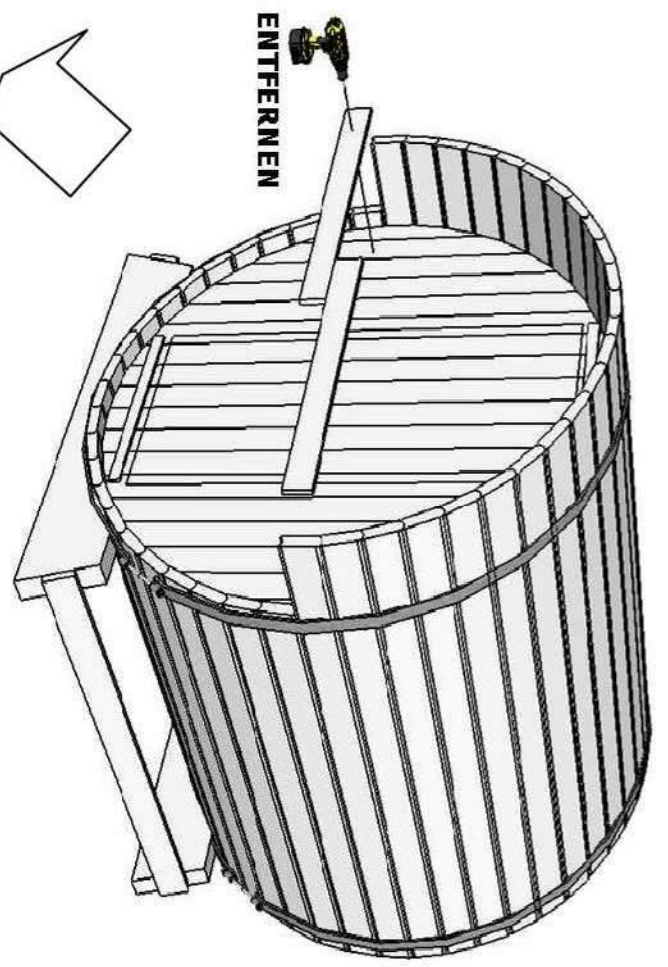
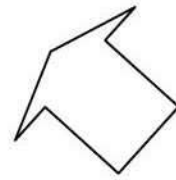
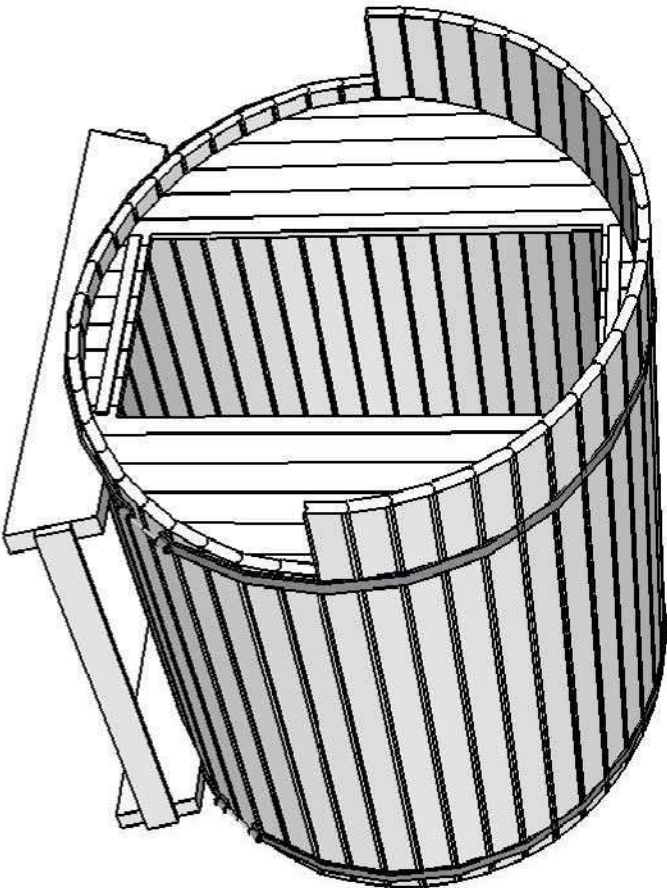
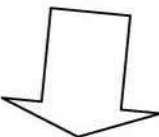

ENTFERNEN

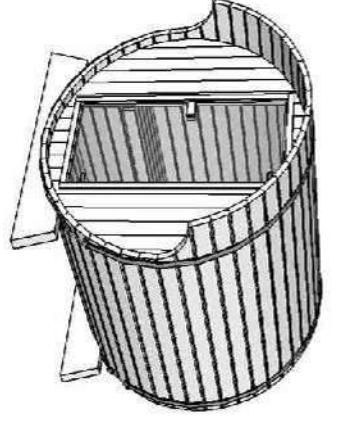

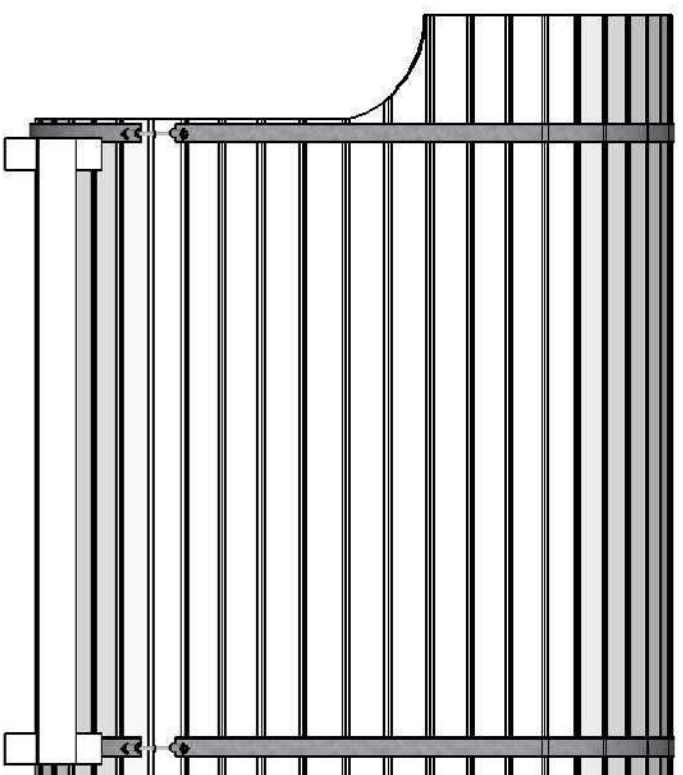
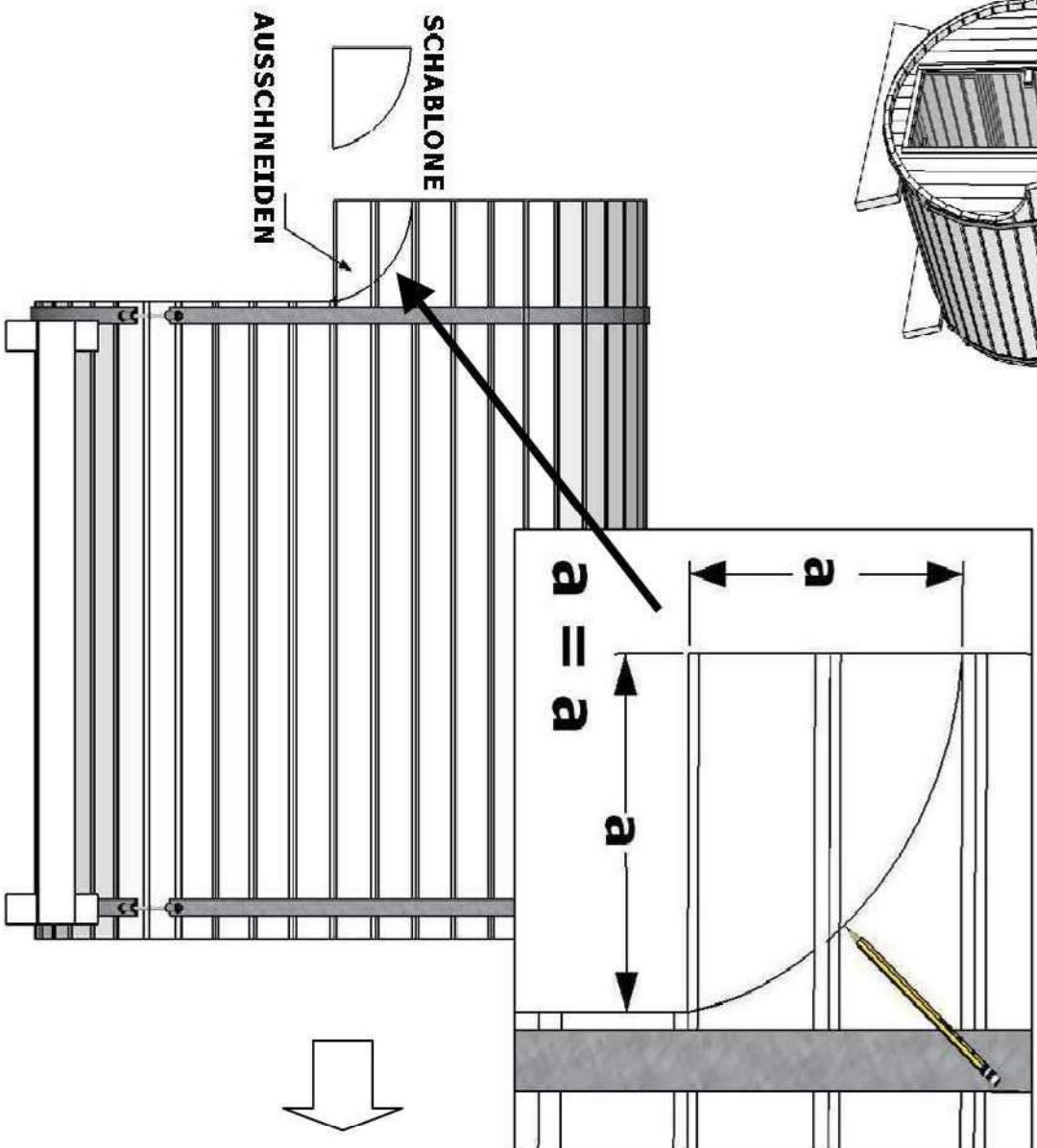
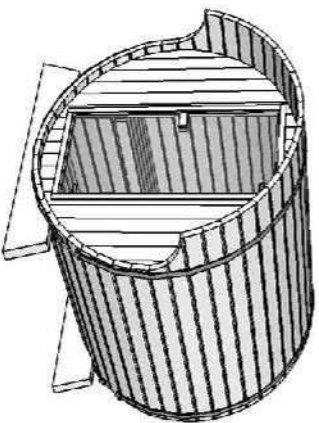

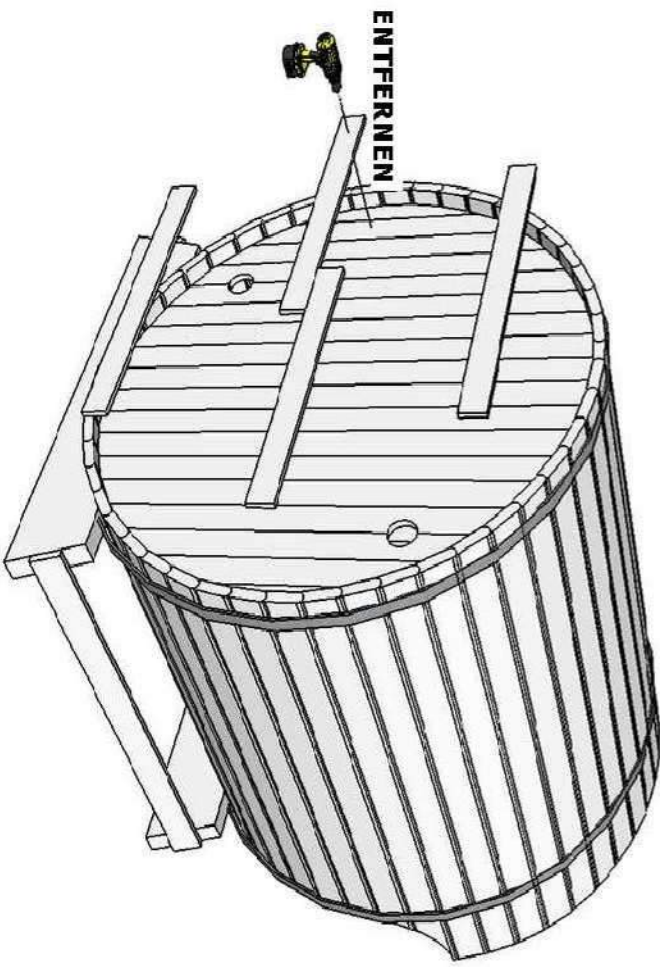
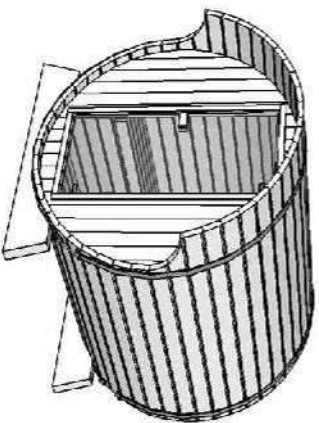

1 x DET R, S, V

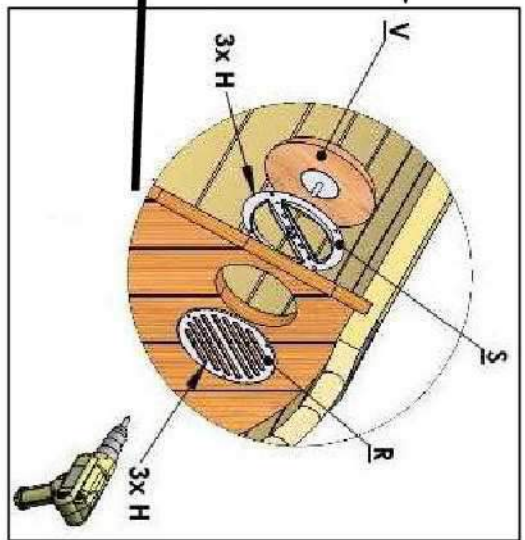

R

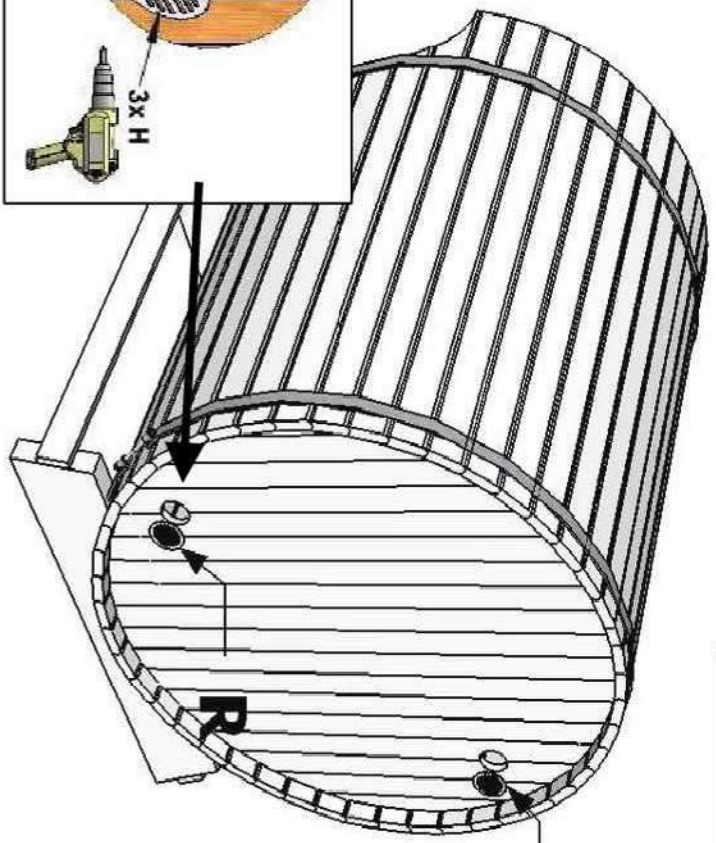

2 x DET R

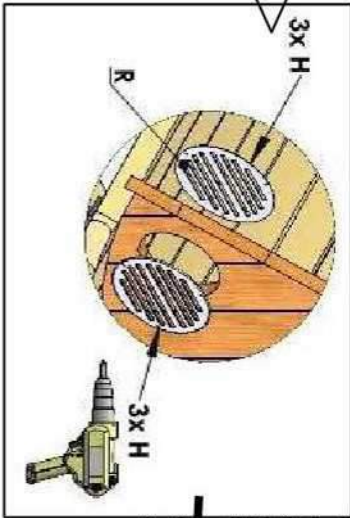

8

9

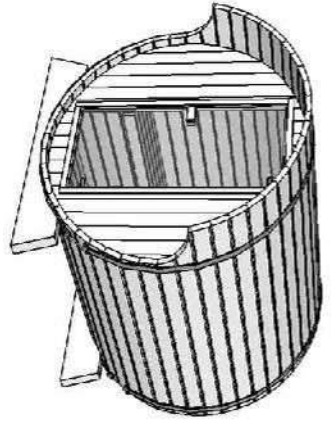

8

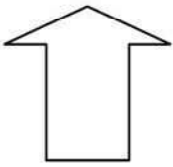
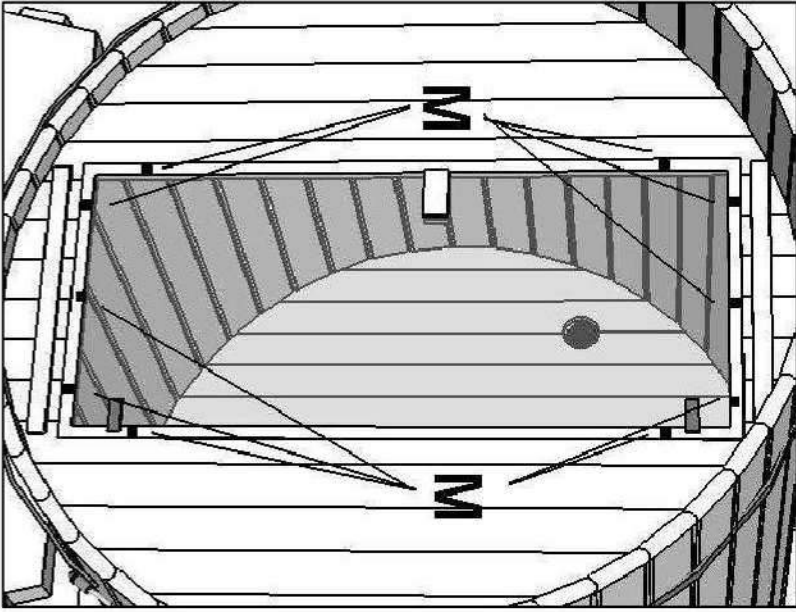
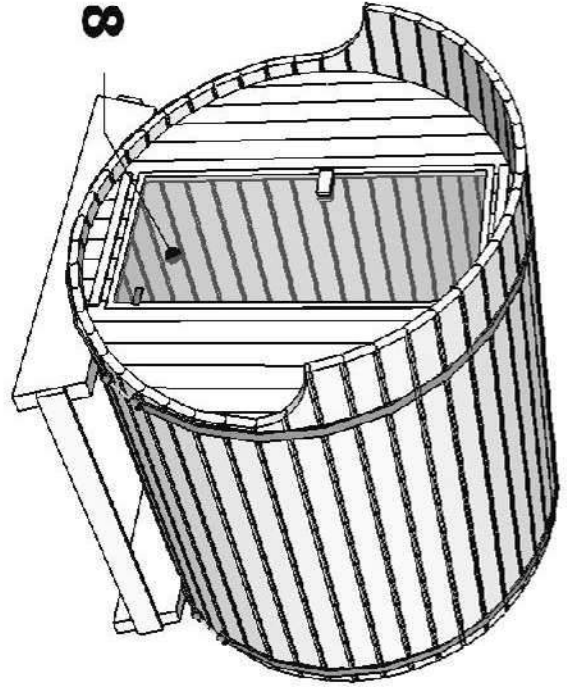

8

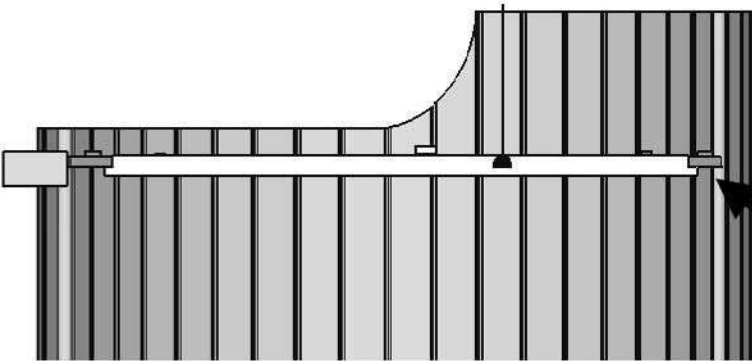

ABSCHNITT

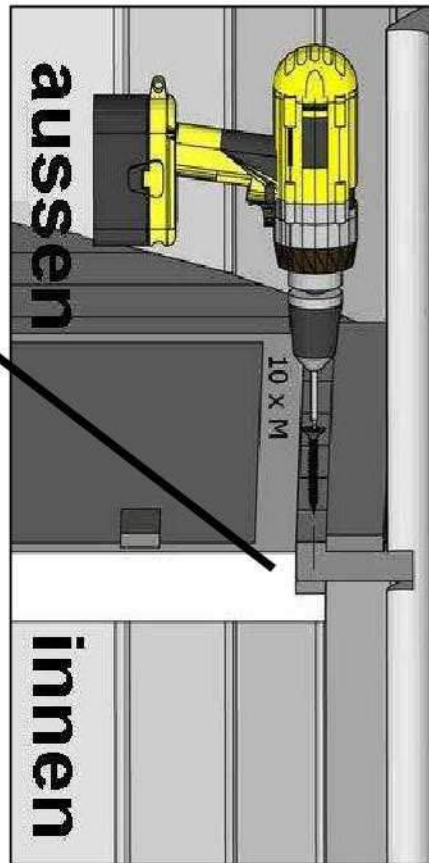

10

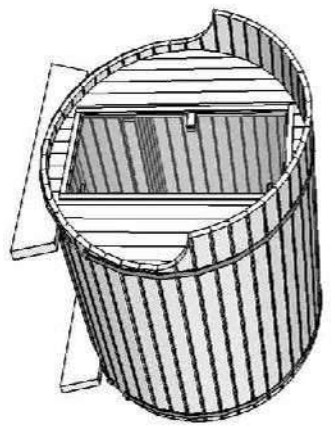
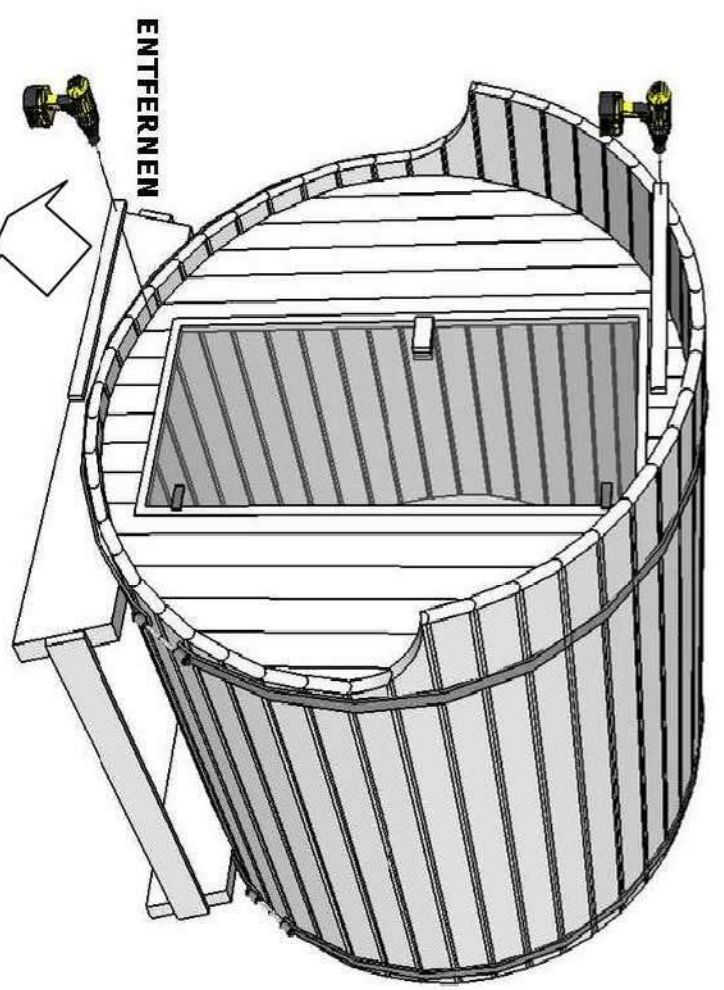
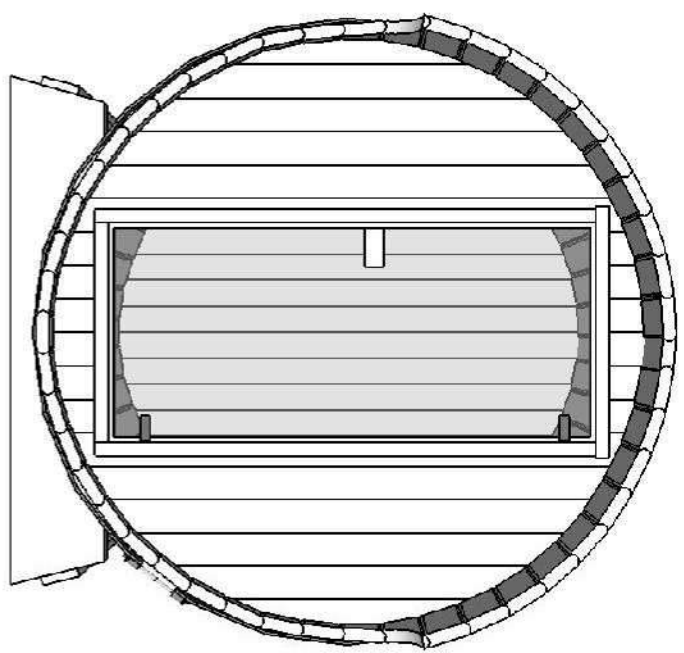
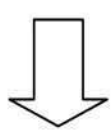
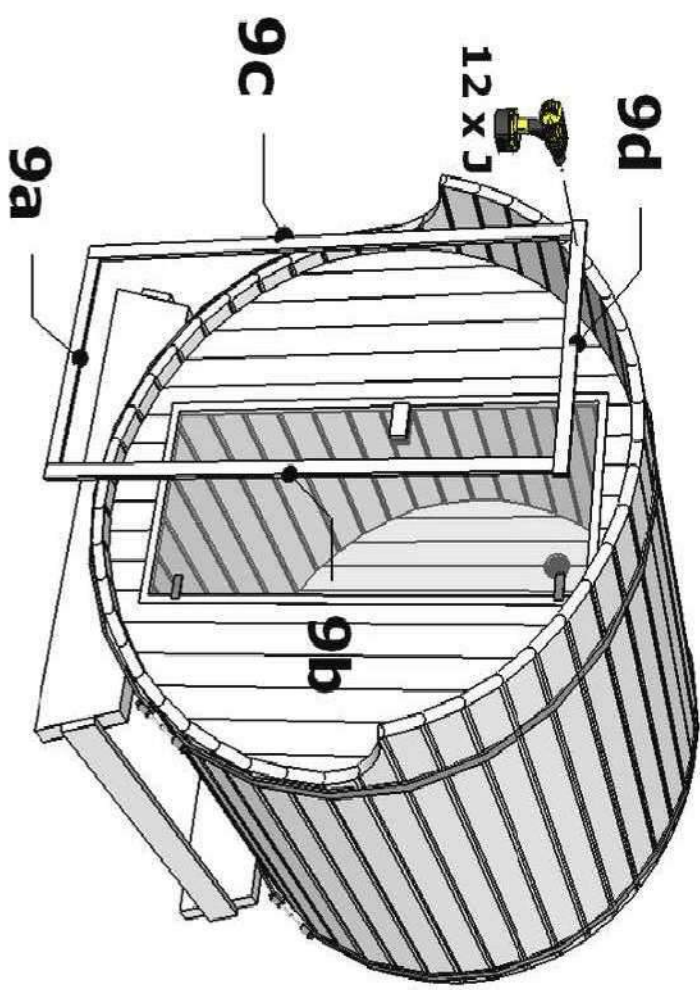

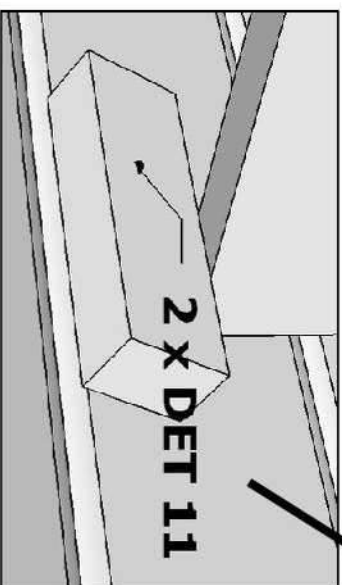
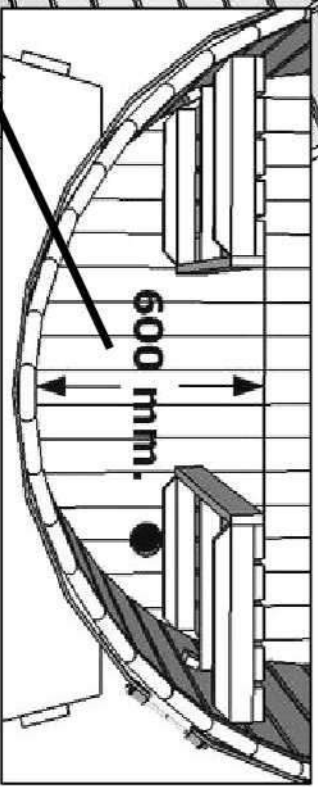
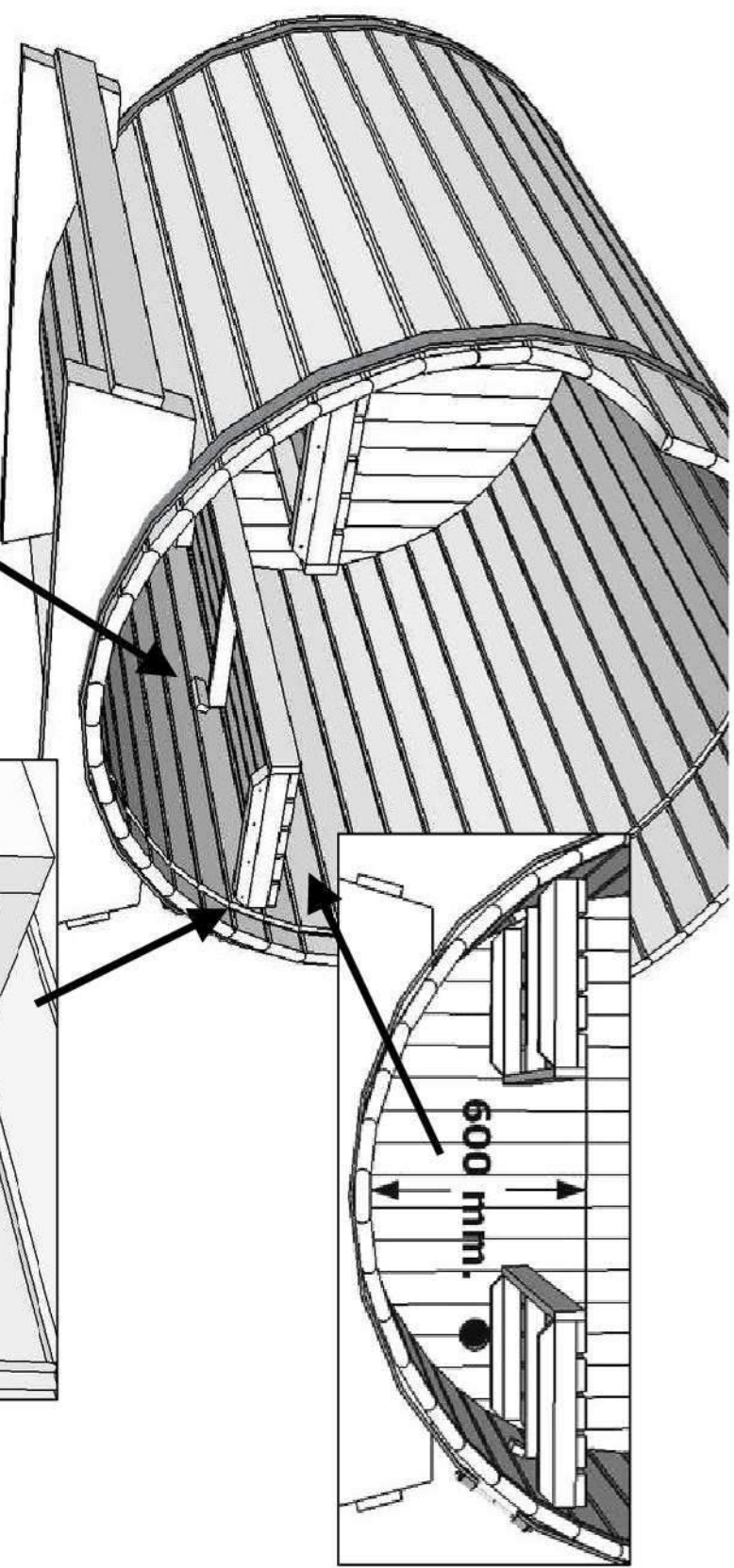
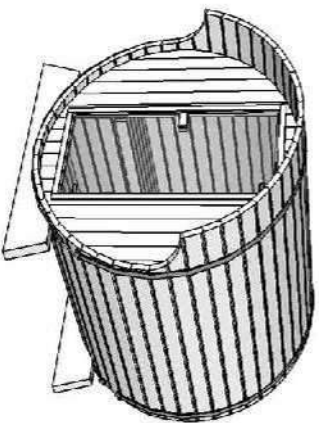

2 x M

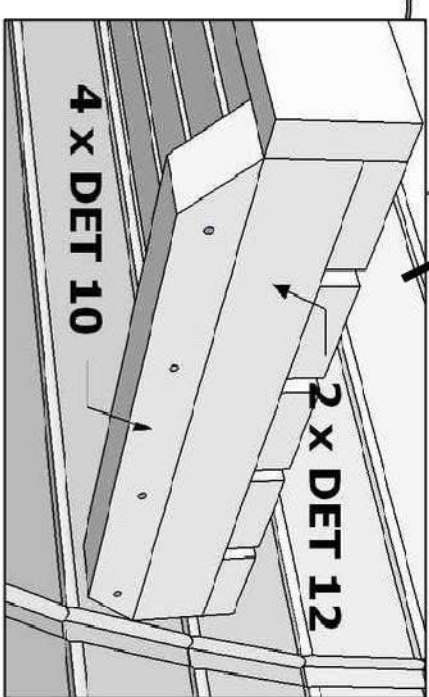

4 x M

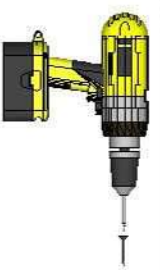

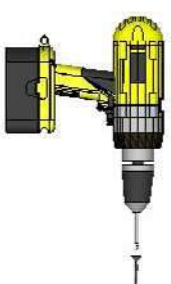
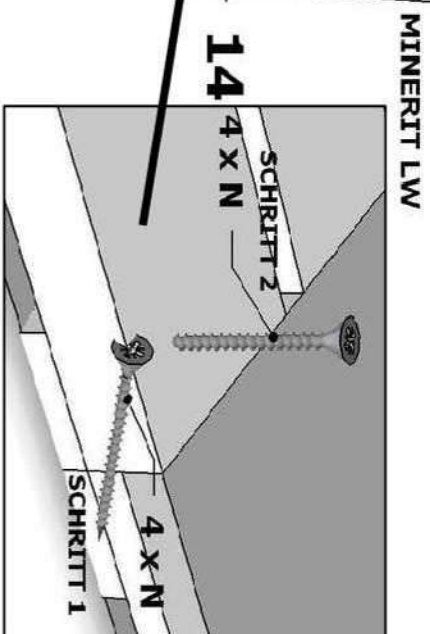
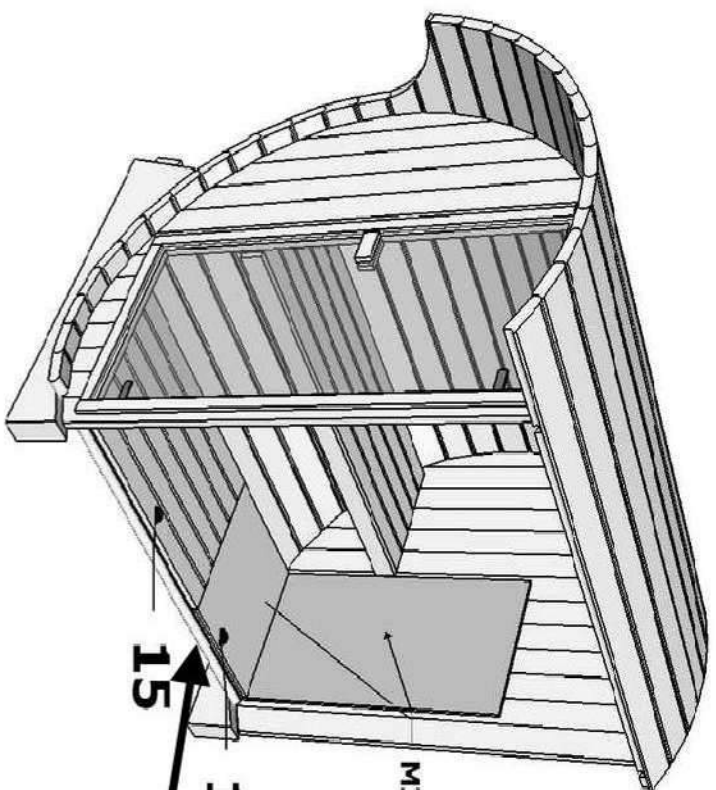
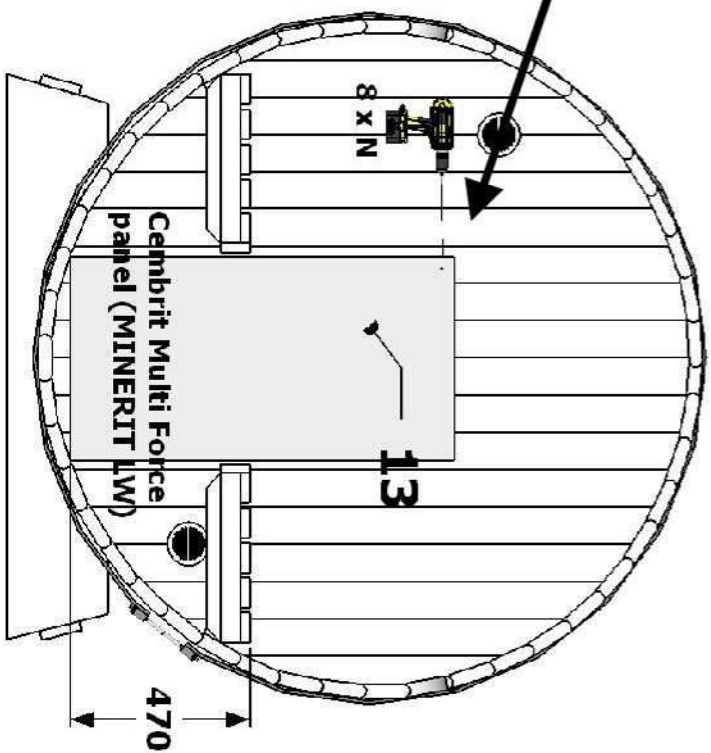
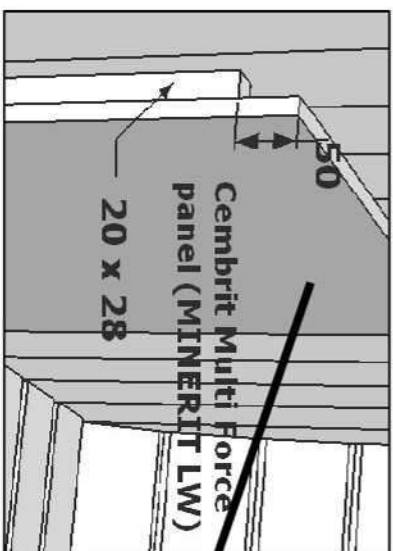
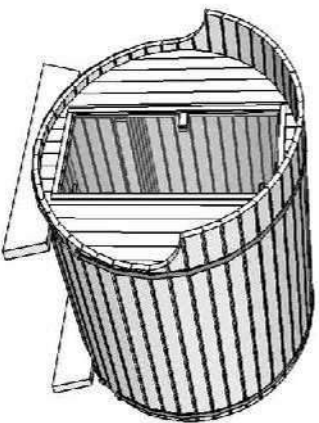

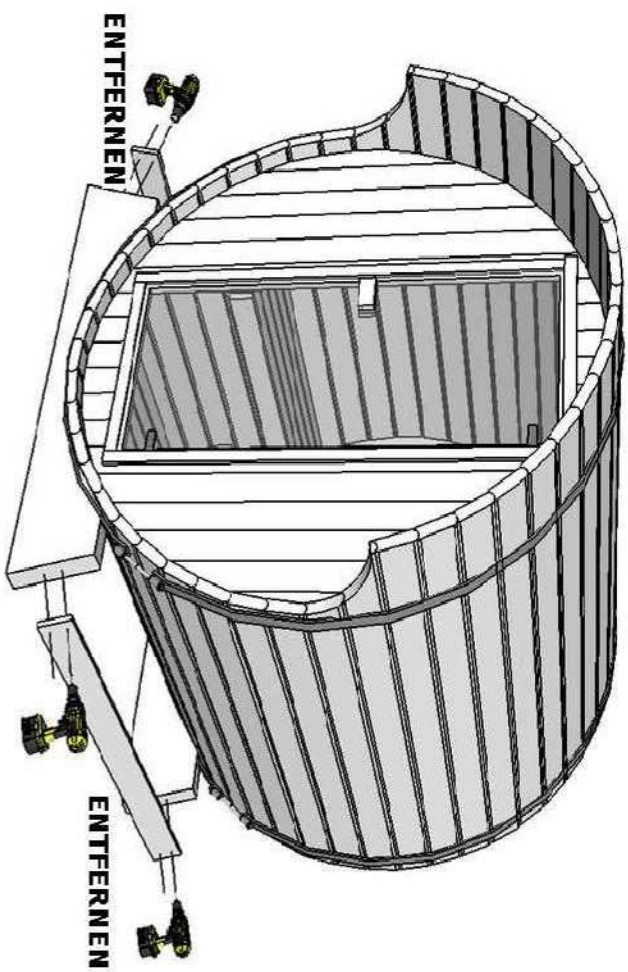
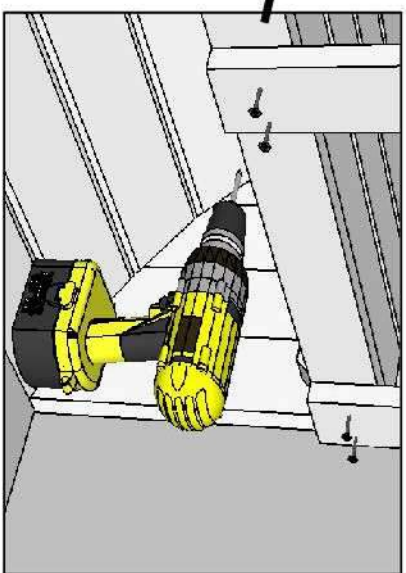
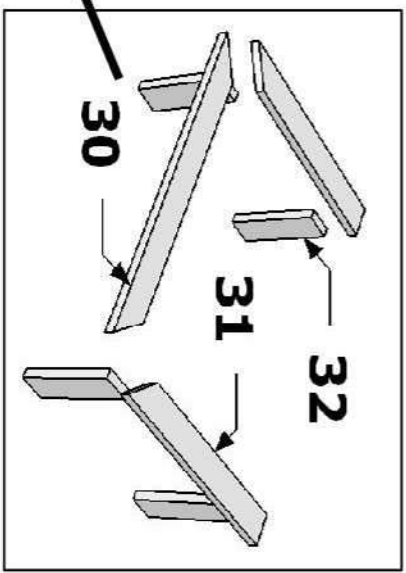
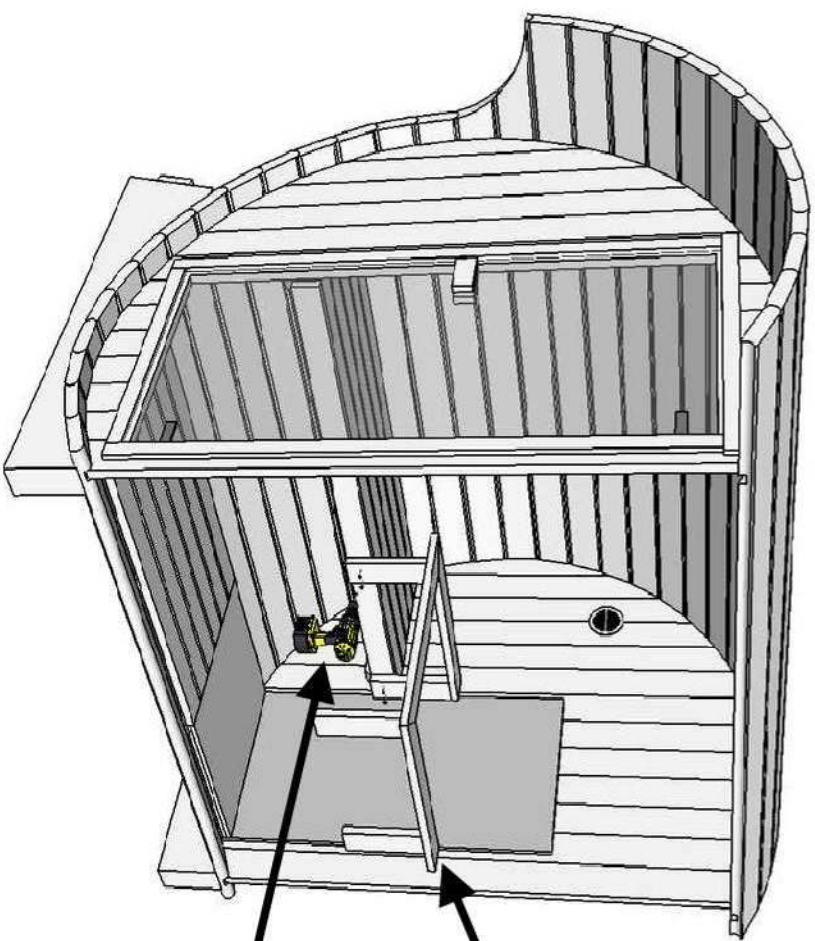
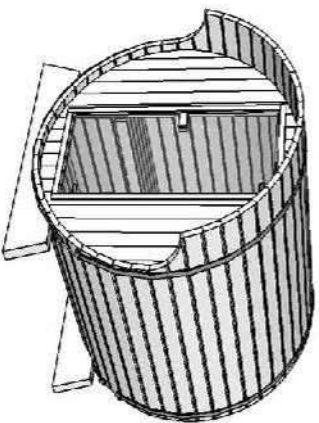

Pflegehinweise „Saunafass“

Vielen Dank das Sie sich für ein komplett montiertes Saunafass entschieden haben.

Der Baustoff Holz ist ein natürlicher Baustoff, welcher Ihnen lange Freude bereiten wird.

Bitte beachten Sie hierzu folgende Pflege und Montagehinweise:

Nach aufstellen des Saunafasses auf ein entsprechend vorbereitetes Fundament, entfernen Sie bitte die seitlichen, unteren Transportbohlen.

In den ersten zwei Jahren muss das Trocknungsverhalten des Holzes genauestens beobachtet werden. Hierzu ist es erforderlich das Saunafass von Zeit zu Zeit nach bzw. zu entspannen.

In den kälteren Jahreszeiten sollte das Fass über die Nachstell-Vorrichtung, entspannt werden. Hierzu lösen Sie die Mutter ca. 4-8 Umdrehungen. (Sollte die Tür klemmen, dann klopfen Sie die Außenbohlen mittels eines Hammers und einem Holzstück vorsichtig nach außen)

In der wärmeren Jahreszeit sollte die Sauna gespannt werden. Hierzu ziehen Sie die Muttern leicht an (Achtung, bitte spannen Sie zwischen den Holztürrahmen ein Holzstück in der Mitte, damit dieser nicht durch das anziehen der Muttern eingedrückt wird)

Die Außenangebrachten runden Blenden müssen an den Stößen einen Spielraum von ca. 5 mm aufweisen. Bitte kontrollieren Sie dieses bei dem Nachspannen. Es kann erforderlich sein das die Blenden bei einem extremen Spannvorgang gelöst werden müssen.

Sollte die Tür klemmen, müssten Sie Ihr Fass über die Spannvorrichtung entspannen.

Das Holz im Außenbereich sollte von Jahr zu Jahr je nach Verwitterung mittels einer Holzschutzlasur aufgefrischt/gestrichen werden.

Der Innenraum bleibt unbehandelt.

Wir empfehlen den Innenraum, je nach Gebrauch, zu desinfizieren.

Legen Sie immer Handtücher auf die Saunaliegen bevor Sie saunieren.

Wir empfehlen nach dem Gebrauch immer einen gefüllten Eimer mit Wasser in die Sauna zu stellen, damit immer eine gewisse Luftfeuchtigkeit im Innenraum besteht.